

**QNAP**

# TBS-453A 4-Bay M.2 SSD NASbook



Use your NAS as a PC



Control Panel



Photo Station



Music Station



Download Station



File Station



myQNAPcloud



Qsync



Antivirus



App Center



Surveillance Station



Free  
Remote  
Control

- Store, backup, and share files with snapshots and versioning
- High security with AES-NI hardware-accelerated encryption
- Play or transcode up to 4K video with dual HDMI outputs
- 3.5mm microphone input & line out audio ports for OceanKTV Karaoke System
- Add up to 8 additional hard drives with a UX-800P/UX-500P expansion unit



Supports 4 x 2242/2260/2280  
M.2 SATA 6Gb/s SSDs



Configure between Switch Mode  
and Private Network Mode with  
the built-in 4-port switch



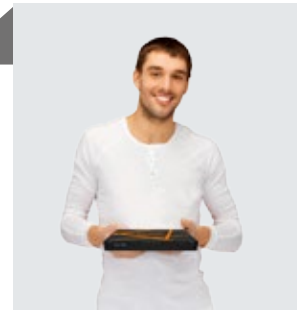

# TBS-453A

## 4-bay M.2 SSD NASbook

Compact, silent, and versatile; the 4-bay M.2 SSD NASbook TBS-453A is ideal for file sharing and multimedia applications with the support of M.2 SATA 6Gb/s SSDs in 2242/2260/2280 form factors. The 14nm Intel® Celeron® quad-core processor provides exceptional performance for intensive tasks, and with a built-in hardware-based 4-port LAN switch, the TBS-453A itself can be a great tool to share network access with multiple users or to create a secure private network. Coupled with its dual HDMI output and 4K video display & transcoding, you can share or present files with high-quality multimedia content stored on the TBS-453A in meetings. The TBS-453A also supports the open-source Linux® platform and allows you to directly utilize feature-rich Linux® apps, enjoying a private cloud that combines storage and IoT applications.



M.2 flash-based SSD (formerly known as the Next Generation Form Factor) is a transition from mSATA which uses the existing PCI Express Mini Card form factor and associated connector. With its remarkably small size and high performance, M.2 SATA SSDs are now widely used in ultrabooks, tablets, and small form factor PCs where space is at premium. The wide adoption of M.2 SATA SSD has led to its price-per-gigabyte becoming increasingly affordable and more suitable for the storage market.



**2 RAM slots, up to 8GB DDR3L RAM**

**Up to 4 x M.2 2280/2260/2242 SATA 6Gb/s SSDs**



**Built-in Hardware Switch for Network Switch Mode or Private Network Mode**

## Compact, quiet, and easily upgradable

Inspired by the design of notebooks, the TBS-453A is a B5-sized compact and portable NAS that be easily set up. The inbuilt fan is isolated for greater noise reduction, and users can easily install/upgrade the RAM and M.2 SSDs by removing the rubber pad and using a thumbscrew to open the NAS.



# Maximized network flexibility with hardware network switch function

The TBS-453A integrates a hardware LAN switch IC and advanced virtual switch functionality providing the maximum network flexibility. By default, you may simply use the LAN port 2-1 to 2-4 as network switch ports, or you may freely configure designated ports as a secure private network. The QTS Network Manager integrates the powerful network management functionality, i.e., TCP/IP, Wi-Fi, and IPv6 management into an overview page incorporating software-defined virtual switch technology. The powerful overview visualization provides you with the most current connection status regardless of the complexity of your network infrastructure and allows you to view real-time traffic flows. Virtual Switches enable greater flexibility and agility in deployment configurations with enhanced centralized management control. Use a virtual switch to build an isolated LAN environment with the built-in DHCP server for accessing IP camera surveillance footage with better data security.

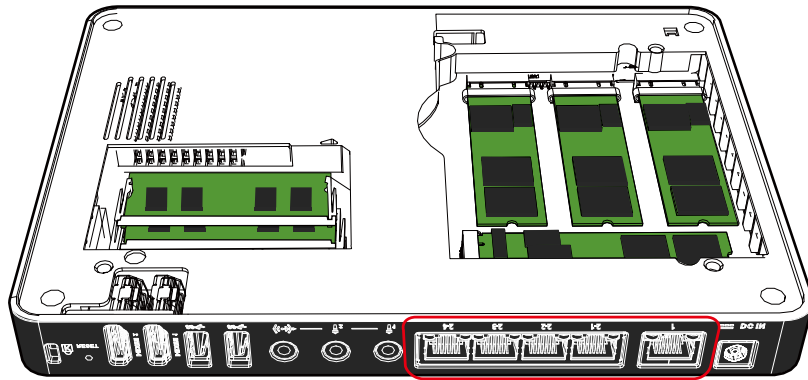

## Network Switch Mode

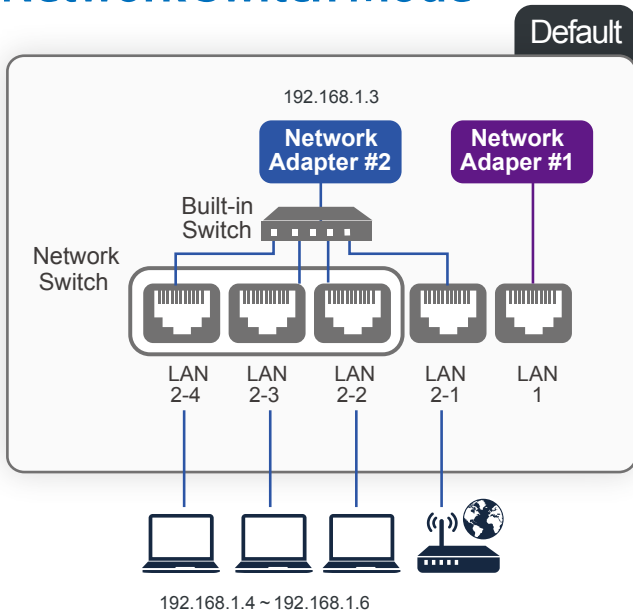

## Private Network Mode

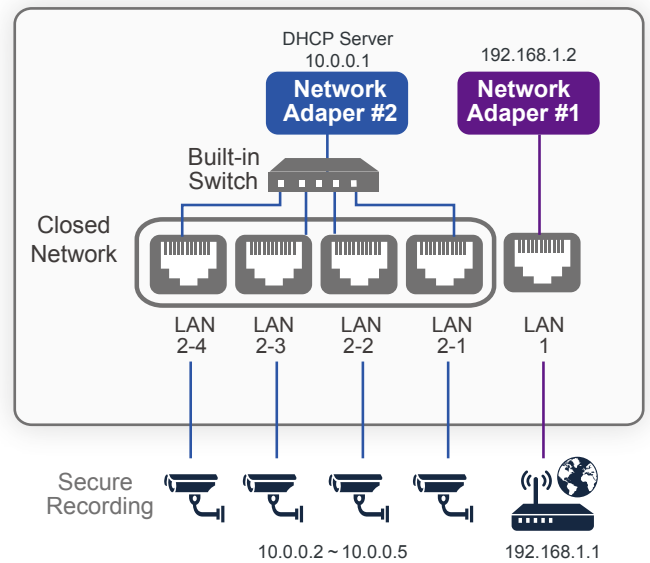



## Use the NAS as a Linux desktop system or for IoT applications



QTS-Linux Dual Systems



Simply connect a USB keyboard and mouse to the TBS-453A, the Linux Station turns the NAS into a full-featured Linux desktop PC via HDMI output. You can also operate the Linux system via a web-based remote desktop. Expand the functionalities of your NAS with the QTS App Center, and exploit the incredibly popular open source Linux Operating System to leverage your NAS as a complete IoT application or development platform.

### Qtips

Install Linux Station from the QTS App Center. Remote Desktop does not currently support audio output.

## 14nm quad-core CPU with AES-NI encryption

The TBS-453A is equipped with an advanced 14nm Intel® Celeron® N3150 quad-core 1.6GHz processor which can automatically burst up to 2.08GHz during high workload. The NAS is equipped with 4GB or 8GB energy-efficient DDR3L-1600 RAM with dual-channel support, up to 4 M.2 2242/2260/2280 SATA 6Gb/s SSDs and Gigabit LAN ports, delivering up to 224MB/s performance while still being incredibly energy efficient. With the AES-NI hardware accelerated encryption performance, the NAS supports over 200MB/s whole NAS encryption or folder encryption for added security. For added convenience, you may also store the decryption key file on a mobile phone or USB thumb drive for automatic unlock.

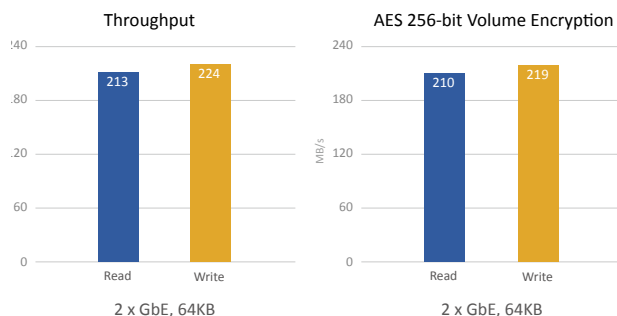

Tested in QNAP Labs. Figures may vary by environment.

Test Environment:

**NAS:**

OS: QTS 4.2.1

Volume type: RAID 5; 4 x 256GB M.2 2280 SSDs; NAS and PCs are connected.

**Client PCs:**

Intel® Core™ i7-4790 3.60GHz CPU; DDR3L 1600Hz 16GB; Seagate 500GB HDD; Intel Gigabit CT ( MTU 1500 ) ;

Windows® 7 Professional 64bit SP1

IOMeter configuration: Multiple PCs via switch. Transferring 32GB file continuously to NAS for 3 minutes. Block size:

64KB for SMB2.0

## Born for server virtualization

Virtualization Station allows you to host virtual machines (VM) on the TBS-453A, and access them via a web browser or VNC. Virtualization Station supports multiple operating systems, VM backup & restoration, VM import/export, and snapshot. Virtualization Station allows the TBS-453A and VMs to share the same LAN port. No longer constrained by physical network performance, high-speed Virtual Switches greatly increases data transfer between VMs as well as between VMs and NAS through the internal interface. QNAP Container Station exclusively integrates LXC and Docker® lightweight virtualization technologies, allowing you to operate multiple isolated Linux® systems on the NAS as well as download apps from the built-in Docker Hub Registry®. Container Station also supports the Online Document app, which allows you to directly view, edit and store document and image files anytime on your NAS.



# Enjoy splendid audiovisual experience with a free remote control

QNAP HybridDesk Station integrates the powerful Kodi™ media player and web browsers. With HDMI connectivity, you can connect the TBS-453A to a HDTV or an A/V receiver to enjoy your rich 4K H.264 multimedia content with up to 7.1 channel audio passthrough\*. The TBS-453A's powerful real-time hardware-assisted transcoding capability facilitate smooth and enhanced playback of 4K videos \*\*. You can even watch YouTube™ videos, surf the web and manage the TBS-453A using a web browser with multilingual keyboard. The TBS-453A includes a free remote control for you to conveniently control HD Station through its built-in IR receiver. With the help of the new smart remote control learning function, you can pair up to three TV or stereo IR remote controls and program your frequently-used buttons and functions. From now on, you'll never again live in fear of losing or damaging your dedicated remote controls\*\*\*. You can also turn your mobile devices into remote controls by installing the Qremote app.



\*A receiver with HDMI support is required for decoding multi-channel surround sound.

\*\* The quality of video and music delivery can vary according to hardware and network environments.

\*\*\* Some remotes may not be compatible.

# Dual HDMI outputs - Switch between HD Station and Linux desktop

The TBS-453A comes with dual HDMI outputs for using two monitors in either a "duplicated" or "extended" desktop configuration. While mirroring displays the same content on both displays, extended desktop mode allows users to display applications over two displays for improved multitasking convenience and productivity. When displaying content using HDMI outputs, you can use the TBS-453A as an amazing multimedia player by using HD Station to enjoy rich apps including Kodi™, HD Player, Plex Home Theater, YouTube™, Spotify®, JRiver, Google Chrome™, Mozilla Firefox®, and more. Alternatively, you can choose to output the Linux® operating system desktop to use the TBS-453A as a PC.



## Superior real-time and offline 4K video transcoding

Featuring advanced 8th-generation Intel® HD Graphics, the TBS-453A supports superior real-time 4K H.264 video transcoding to convert videos to universal formats that can be smoothly played on PCs, mobile devices and Smart TVs. With offline transcoding, even when you can only connect using a low-speed Internet connection, you can still enjoy smooth video playback via File Station, Video Station, and the Qfile mobile app by selecting a pre-rendered lower resolution video. The TBS-453A also allows you to set a dedicated folder for automatic video transcoding.



## Showcase of invention and creativity following the Maker Movement

Started ten years ago on the west coast of the United States, the Maker Movement envisions a future of people as makers instead of consumers, and is becoming increasingly popular around the world. Makers combine self-reliance, open-source learning, modern design, and technology to become independent inventors, designers and tinkerers. Whether they are tech enthusiasts, educators, tinkerers, hobbyists, engineers, science clubs, artists, or students, the TBS-453A can provide a great starting point for makers to develop and demonstrate their creations with the world. From developing and testing apps on virtual machines to demonstrating them through the integrated HDMI output, the TBS-453A can provide the inspiration and functionality needed to turn a dream into reality.





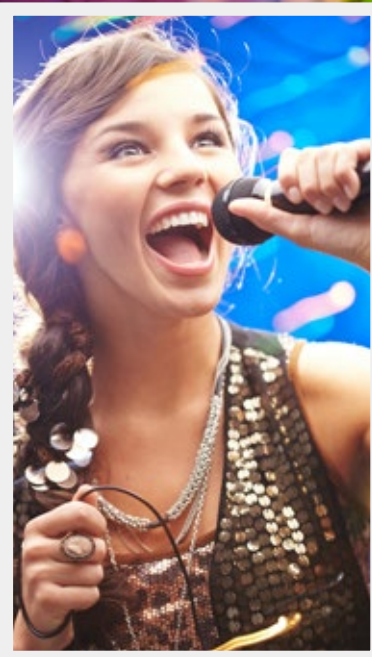

## Get the party started

Whether you are throwing a child's birthday party, or an adult birthday party, the TBS-453A can be the center of entertainment. With its rich hardware and software features, the TBS-453A is the first and final stop for birthday party events. You can connect wireless microphones and speakers to the NASbook and begin the party.



## Enjoy your exclusive karaoke system with OceanKTV

OceanKTV allows you to create a quality karaoke experience at home or in the workplace. Simply attach an HDMI TV or monitor to the TBS-453A and start singing with OceanKTV. With the OceanKTV mobile app you can easily control the entire experience on your tablet. Enjoy it alone or with your friends! The TBS-453A has two 3.5mm dynamic microphone jacks for connecting up to two dynamic microphones.



## Smart QTS 4.2.1 for data storage, backup and file sharing

The intuitive QTS 4.2.1 O.S. provides real-time system information monitoring, and multiple application windows with multi-tasking capability. The TBS-453A supports SMB/CIFS, NFS, and AFP protocols for file sharing across Windows®, Mac®, Linux®/UNIX® networks. Data, logs and ISO images of CDs and DVDs can be centrally stored on the TBS-453A and protected by an integrated antivirus solution. The Windows AD® and LDAP services enable system administrators to configure user permissions by using an existing Windows AD server, LDAP server or built-in LDAP service. The NAS supports SAMBA v4 and can act as a Windows domain controller to manage privilege settings.



## Well-rounded backup solutions to secure data

QNAP NetBak Replicator supports real-time and scheduled data backup on Windows including Outlook email archiving. Apple Time Machine® is also supported to provide Mac® OS X users with a solution to effortlessly back up data to the TBS-453A. HybridBackup Sync supports not only Rsync backup, but also Real-Time Remote Replication (RTRR) to backup the NAS data to another NAS or a remote FTP or CIFS/SMB server. The leading cloud storage services such as Amazon® Cloud Drive, Google™ Drive, Dropbox™, and Microsoft® OneDrive® are also supported for synchronization with designated folders.





## Restore files with Snapshot

QTS Storage Manager adds a web-based snapshot tool for you to easily backup and restore data on the TBS-453A back to any point of time. You can take snapshots for both volumes and LUN (up to 256 snapshots per volume or LUN and maximum 1024 snapshots per NAS), efficiently replicate volume/LUN snapshots via Snapshot Replica to remote servers by copying only the changes made, and quickly clone a volume /LUN snapshot as a local volume without interrupting the current system operation. You can even set up the system to automatically take a snapshot of the volume before backup via RTRR/rsync, even when the file is opened.

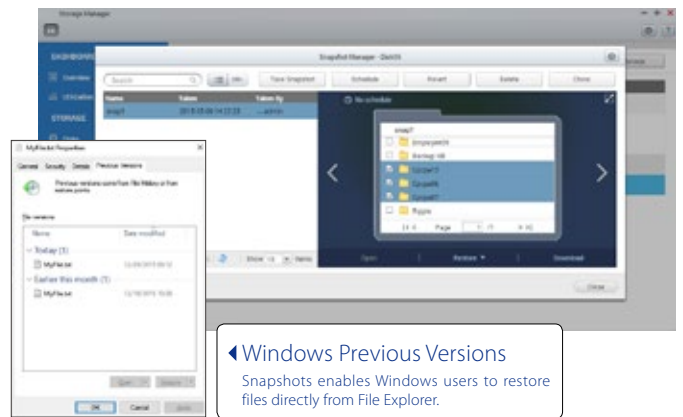

## Comprehensive security options

The TBS-453A provides numerous security options, such as encrypted access, IP blocking, and more. IT administrators can also control the access rights of each user to different folders. The TBS-453A supports AES 256-bit volume and folder encryption, preventing sensitive business data from unauthorized access and breach even if the hard drives or the entire system were stolen. In addition to email and SMS, you can get messages sent to your mobile devices via the Qmanager mobile app in the event of a system failure or other warning. The Two-Step Verification requires users to log in to the QNAP NAS with both their passwords and a 6-digit one-time password (OTP) generated by an authenticator app such as the Google Authenticator on Android, iOS, or BlackBerry, or the Authenticator on Windows Phone. To simplify the log in process, trusted devices (e.g. home computer) can be "remembered" without additional verification.



## VPN server

A virtual Private Network (VPN) enables secure connections to access network resources and services across a public network. A VPN offers a convenient solution for NAS users to build end-to-end L2TP/IPsec, PPTP, or OpenVPN encrypted tunnels to your QNAP NAS. The VPN server also comes with user and connection management to help you manage VPN services. Furthermore, a VPN can help gain access to resources that may otherwise be restricted by your network environment.

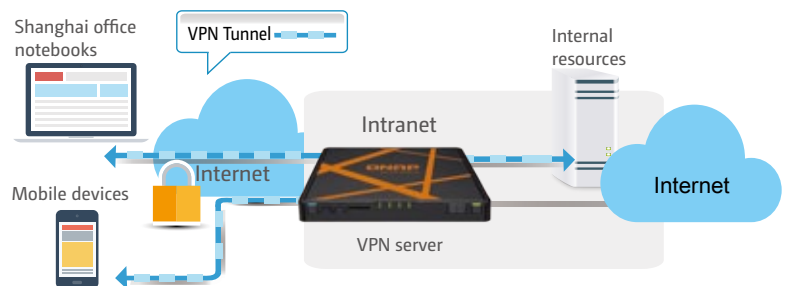

## VPN client

When the NAS acts as a VPN client, VPN can provide secure data transmission. You can set up remote site backup with secure data transmission. For example, configure the NAS to be a VPN client for secure data transmission when setting up backup or other services to branch offices at remote locations. A single VPN Client can also support multiple VPN connections to different VPN servers.

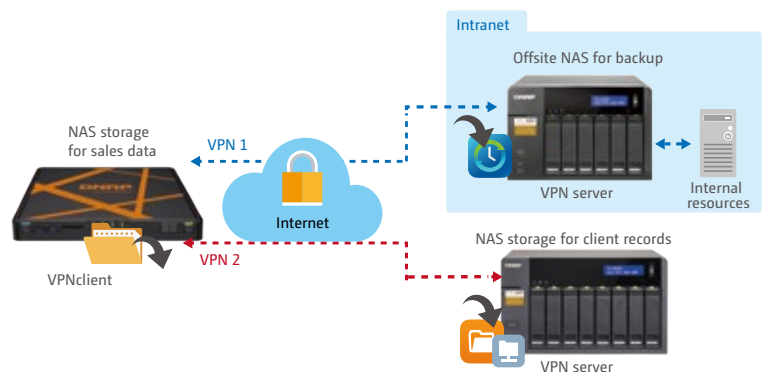

## Qsirch - a smarter, faster way to search

Qsirch uses fine-grained indexing conditions in combination with its full-text search capabilities to support searching over 6,000 file types. Powered by TF-IDF algorithm and a near real-time search engine, the Qsirch enables users to search while typing and sort through files faster and more precisely.



## Qsirch browser add-on for Google Chrome

Install the Qsirch add-on to enable Qsirch from your web browser. Simply click on the Qsirch icon on the right of the address bar to search Google and your QNAP NAS simultaneously. Your Qsirch and Google search results will appear side-by-side for quick and convenient comparison.



• Chrome add-on Qsirch Helper

## Content preview

Thumbnail previews for photo, videos, and PDFs makes searching and browsing through voluminous data a lot faster, while the highlighted keywords found within documents further helps you to quickly find what you're looking for. Moreover, the Gmail\* preview function enables you to preview emails and your Gmail backup files easily and quickly.



**Qtips** Supports .eml file previewing.

## Organization of results by type, and other attributes

Your search results can be filtered and organized by various types including photos, music, videos, and documents. Results can also be organized based on criteria such as date modified, file size, and many other standard file descriptors.



## Share directly from your search results

Qsirch 2.1 displays previews of your search results. Save time and share the content of your search results, directly from the previews. It could not be easier!

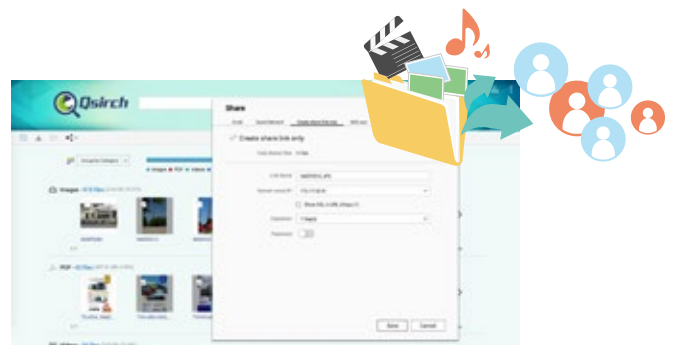

### Enhance productivity with multiple USB 3.0 ports

Direct-attached Storage (DAS) devices such as USB hard drives are incredibly convenient in portability, but they fall short in file sharing and functionality and can only be connected to one server or PC at one time. By connecting a DAS to the TBS-453A you can easily share its content with other users without having to unplug and move it around. The USB ports on the TBS-453A also support devices such as UPS and printers for greater all-round functionality.

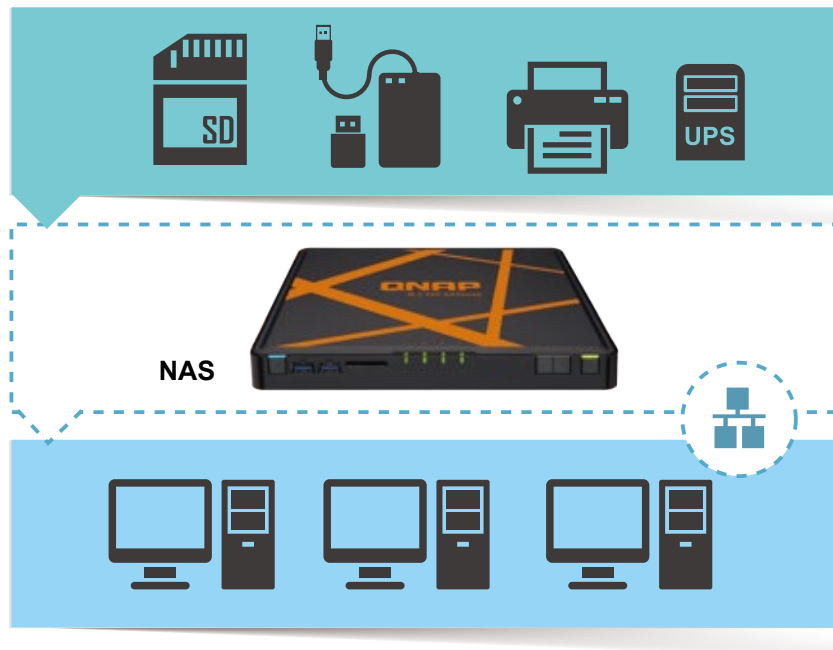

### Cloud-ready 24 x 7 surveillance solution

Surveillance Station is a professional network surveillance Video Management System (VMS) that offers a user-friendly management interface, over 3,000 compatible IP camera models, and expandable IP camera channel licenses. It supports real-time monitoring, video & audio recording and playback with a wide range of customizable settings. You can also install the Vmobile app on your iOS® or Android™ devices to manage monitored channels anytime and anywhere to safeguard your office environment, or install the Vcam mobile app to turn your device into a network camera to instantly record to your NAS. The TBS-453A includes 4 free IP camera channels and you can expand up to 40 channels by purchasing additional licenses .



## Install-on-demand apps to extend NAS functionality

The built-in App Center provides various install-on-demand apps developed by QNAP and third-party developers, including tools for backup/sync, business, content management, communications, download, entertainment, and much more. It is also a centralized location for managing & updating installed apps, allowing you to directly update applications once newer versions are released.

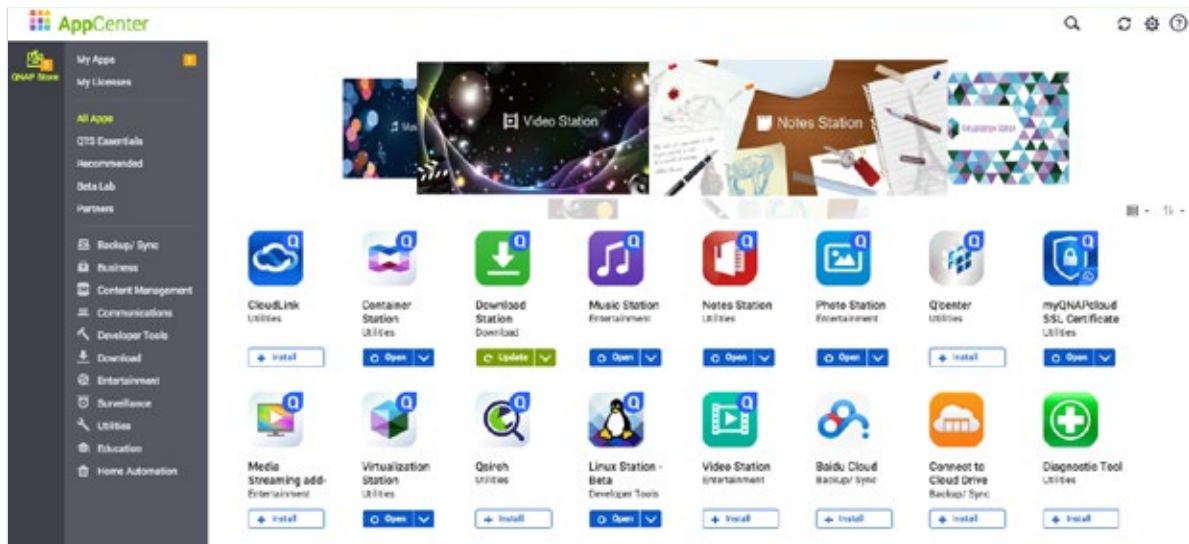

## Easily expand storage capacity

The TBS-453A supports online capacity expansion for archiving rapidly-growing data by connecting a QNAP expansion enclosure. With the QNAP scale-up solution, the raw storage capacity can be expanded on demand\*, making the TBS-453A an ideal file center with large storage capacity for storage-intensive business applications such as video surveillance, data archiving, high-quality video storage, and more. With the support of QJBOD Express (JBOD enclosures roaming)\*\*, you can just connect a large capacity QNAP expansion enclosure to the TBS-453A, and migrate data to another NAS through the JBOD enclosure without network connectivity.



The maximum raw storage capacity available by connecting a QNAP expansion enclosure:

QNAP NAS Model	RAID Expansion Enclosure	No. of RAID Expansion Enclosure	Extra HDD No.
TBS-453A	UX-800P	1	8 x 3.5" HDDs
	UX-500P	1	5 x 3.5" HDDs

\*To expand the storage space with an UX expansion enclosure, you must create a separate static volume or storage pool on the UX expansion unit.  
\*\*RAID groups of storage pools cannot cross multiple enclosures.





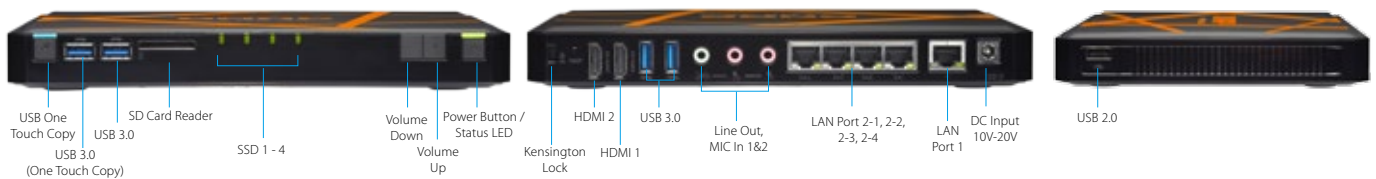

## 4-Bay M.2 SSD NASbook

# Hardware Specifications



Ordering P/N	TBS-453A-4G-960GB	TBS-453A-4G-480GB	TBS-453A-4G	TBS-453A-8G-960GB	TBS-453A-8G-480GB	TBS-453A-8G
Processor	14nm Intel® Celeron® N3150 quad-core 1.6GHz, burst up to 2.08GHz					
Floating Point Unit	✓					
Hardware Encryption Acceleration	✓ (AES-NI)					
GPU	8th generation Intel HD Graphics					
System Memory	4GB ( 2 x 2GB )			8GB ( 2 x 4GB )		
Maximum Memory	8GB					
Memory Slot	2, SODIMM DDR3L-1600 (*For dual-DIMM configurations, you must use a pair of identical DDR3L RAM modules.)					
Flash Storage	4GB (system firmware storage)					
Drive Type	4 x M.2 2280/2260/2242 SATA 6Gb/s SSDs					
Pre-installed M.2 SSDs	4 x 240GB	2 x 240GB	-	4 x 240GB	2 x 240GB	-
Raw Capacity	960GB (RAID 0)	480GB (RAID 0)	Optional purchase	960GB (RAID 0)	480GB (RAID 0)	Optional purchase
Default Capacity (Factory Configuration)	720GB (RAID 5)	240GB (RAID 1)	Optional purchase	720GB (RAID 5)	240GB (RAID 1)	Optional Purchase
Network	5 Gigabit RJ45 Ethernet ports (LAN port 2-1, 2-2, 2-3, 2-4 are designed as switch ports)					
USB Port	4 x USB 3.0 & 1 x USB 2.0 ports Support USB printer, pen drive, and USB UPS, etc.					
Video Output	2 x HDMI, up to 4K 2160P Ultra HD support					
Audio Input	2 x 3.5mm microphone jack (dynamic microphone only)					
Audio Output	1 x Built-in Speaker & Line Out Jack (for amplifier or headphone amplifier)					
LED	Status/Power, USB, SSD 1-4					
Button	Power, USB one-touch-backup, Reset, Volume Up, Volume Down					
SD Card Reader	✓, up to 128GB					
IR Receiver	✓, support QNAP RM-IR002, RM-IR003 and MCE-compatible Remote Control					
Security	Kensington security slot					
Dimension (HxWxD)	25 x 230 x 165 mm / 0.98 x 9.06 x 6.50 inch					
Weight	760g / 1.68lbs.	742g / 1.64lbs.	724g / 1.60lbs.	760g / 1.68lbs.	742g / 1.64lbs.	724g / 1.60lbs.
Working Temperature	0 - 40 °C (32 - 104 °F)					
Relative Humidity	5~95% RH non-condensing, wet bulb: 27°C					
Power	DC10V-20V wide input range					
Fan	Compact internal fan					
Package Contents	NASbook, 19V AC adapter, power cord, quick installation guide, Ethernet cable x 2, remote control, SSD installation kit					

## Accessories

	Category	Model No.	Product description
Expansion Enclosure		UX-800P	QNAP 8-bay expansion enclosure, 7.3 kg / 16.08 lbs 185.2 x 298.2 x 235.4 mm / 7.29 x 11.74 x 9.27 inch (H x W x D)
		UX-500P	QNAP 5-bay expansion enclosure, 5.1 kg / 11.24 lbs 185.2 x 210.6 x 235.4 mm / 7.29 x 8.29 x 9.27 inch (H x W x D)
Memory		RAM-2GDR3L-SO-1600	2GB DDR3L RAM, 1600 MHz, SO-DIMM
		RAM-4GDR3L-SO-1600	4GB DDR3L RAM, 1600 MHz, SO-DIMM
		RAM-8GDR3L-SO-1600	8GB DDR3L RAM, 1600 MHz, SO-DIMM
Remote Control		RM-IR002	QNAP IR Remote Control (shipped with the product)



# Software Specifications

## Operating System

- QTS 4.2 (embedded Linux)

## Supported Client OS

- Windows 7 (32/64-bit), Windows 8 (32/64-bit), Windows Server 2003/2008 R2/2012/2012R2
- Apple Mac OS X
- Linux & UNIX

## Supported Browsers

- Microsoft Internet Explorer 10+
- Mozilla Firefox 8+
- Apple Safari 4+
- Google Chrome

## Multilingual Support

- Chinese (Traditional & Simplified), Czech, Danish, Dutch, English, Finnish, French, German, Greek, Hungarian, Italian, Japanese, Korean, Norwegian, Polish, Portuguese (Brazil), Romanian, Russian, Spanish, Swedish, Thai, Turkish

## File System

- Internal Hard Drive: EXT4
- External Hard Drive: EXT3, EXT4, NTFS, FAT32, HFS+

## Networking

- TCP/IP (IPv4 & IPv6: Dual Stack)<sup>1</sup>
- Gigabit NICs with jumbo frame (Port trunking & failover are not supported.)
- Built-in hardware network switch with switch mode and private network mode support
- Service binding based on network interfaces
- Squid Proxy server
- Proxy client
- DHCP client, DHCP server
- Protocols: CIFS/SMB 3.0, AFP (v3.3), NFS(v3), FTP, FTPS, SFTP, TFTP, HTTP(S), Telnet, SSH, iSCSI, SNMP, SMTP, and SMSC
- UPnP & Bonjour Discovery
- USB Wi-Fi Adapter Support

## Security

- Network access protection with auto-blocking: SSH, Telnet, HTTP(S), FTP, CIFS/SMB 3.0, AFP
- CIFS host access control for shared folders
- FIPS 140-2 validated AES 256-bit volume-based and shared folder data encryption<sup>2</sup>
- AES 256-bit external drive encryption<sup>2</sup>
- Importable SSL certificates
- Instant alerts via email, SMS, beep, push service, and LCD panel<sup>3</sup>
- 2-step verification

## Storage Management

- Storage Space Utilization monitoring
- QNAP flexible Volume/LUN with thin provisioning and space reclamation<sup>1</sup>
- Disk volume types: RAID 0, 1, 5, 6, 10, 5 + hot spare, JBOD, single
- Supports storage pools
- Supports volume/LUN snapshots
  - Snapshot clone, vault, replica
  - Snapshot agent for Microsoft Windows and VMware vSphere
- Online volume expansion
- Online storage pool expansion
- Online RAID capacity expansion and online RAID level migration
- SMART data migration
- Storage expansion via a QNAP UX-500P/UX-800P expansion unit
- JBOD enclosure roaming
- SSD read-only/read-write cache
- Bad block scan and hard drive S.M.A.R.T.
- Bad block recovery & RAID recovery
- Bitmap support

## Power Management

- Wake on LAN
- Internal hard drive standby mode
- Scheduled power on/off
- Automatic power on after power recovery
- USB and network UPS support with SNMP management
- System sleep mode (S3)

## Access Right Management

- Batch users creation
- Import/Export users
- User quota management
- Local user access control for CIFS, AFP, FTP, and WebDAV
- Application access control for Photo Station, Music Station, Video Station, and File Station

- Subfolder permissions support for CIFS/SMB 3.0, AFP, FTP, and File Station

## Domain Authentication Integration

- Microsoft Active Directory (AD) & Domain Controller support
- LDAP server, LDAP client
- Domain users login via CIFS/SMB 3.0, AFP, FTP, and File Station

## myQNAPcloud Service

- Private cloud storage and sharing
- Free host name registration (DDNS)
- Optional myQNAPcloud SSL certificates (DDNS)
- Auto router configuration (via UPnP)
- Web-based file manager with HTTPS 2048-bit encryption
- CloudLink for remote access without any complicated router setup
- myQNAPcloud connect for easy VPN connection (Windows VPN utility)

## Qsync

- Sync files across multiple devices with SSL secure connection
- Selective synchronization for only syncing specific folders
- Use team folders as a file center for greater team collaboration (maximum sync tasks: 32)
- Shares files by links via e-mail
- Policy settings for conflicting files and file type filter support
- Version control: up to 64 versions.
- Unified configuration management
- Supports remote erase/restore
- Supports Windows & Mac OS

## Web Administration

- Multi-window, multi-tasking based system management
- Smart toolbar and dashboard for neat system status display
- Resource monitor
- Network recycle bin for file deletion via CIFS/SMB 3.0, AFP, and File Station
- Automatic Cleanup
- File Type Filter
- Comprehensive logs (events & connection)
- Syslog client/server
- System settings backup and restore
- Mobile app: Qmanager for remote system monitoring & management

## File Server

- File sharing across Windows, Mac, and Linux/UNIX
- Windows ACL
- Advanced folder permissions for CIFS/SMB 3.0, AFP, FTP
- Shared folder aggregation (CIFS/SMB 3.0)

## FTP Server

- FTP over SSL/TLS (Explicit)
- FTP support

## File Station

- Supports mounting cloud drives (such as Google Drive, Dropbox, Microsoft OneDrive, Amazon Cloud Drive, Yandex Disk and Box).
- Supports mounting remote shared folders through FTP, WebDAV or Microsoft networking (CIFS/SMB 3.0)
- Supports opening documents via Office Online, Google Docs or Chrome Extension (Edit Office files in Google Docs, Sheets, and Slides)
- Supports ISO Mounting (Up to 256 ISO Files)
- Supports sharing download links and upload links
- Drag-n-drop Files via Chrome and Firefox Browsers
- Photo, music, and video preview and playback with hardware-accelerated transcoding
- File Compression (ZIP or 7z)
- Creation of and sending download links for sharing public files with expiration date and password protection
- Supports displaying subtitles (\*.SRT, UTF-8 format)
- Mobile App: Qfile for file browsing and management

## Transcode Management

- Transcode video files to 240p, 360p, 480p, 720p and 1080p resolution
- Automatic video transcoding for watched folders
- Hardware accelerated transcoding support
- Embed subtitles into videos for background transcoding

## Backup Station

- Remote replication server (over rsync)
- Real-time remote replication (RTRR) to another QNAP NAS or FTP server

- Works as both RTRR server & client with bandwidth control
- Real-time & scheduled backup
- Backup versioning for RTRR
- Snapshot support for RTRR/Rsync
- Encryption, compression, file filter, and transfer rate limitation
- Desktop backup with QNAP NetBak Replicator for Windows
- Apple Time Machine backup support
- Data backup to multiple external storage devices
- Synchronizes with cloud storage: Amazon S3, ElephantDrive, Symform, Dropbox, and Google Drive
- Third party backup software support: Veeam backup & replication, Acronis True Image, Arcserve backup, emc retrospect, Symantec Backup Exec, etc.

## Print Server

- Max number of printers: 3
- Supports Internet Printing Protocol
- Print job display and management
- IP-based and domain name-based privilege control

## Cloud Backup Station

- Amazon S3
- Amazon Glacier
- WebDAV-based cloud storage
- Microsoft Azure
- OpenStack

## AirPlay & Chromecast

- Streams videos, photos and music from NAS to Apple TV or Chromecast via File Station, Music Station, Photo Station, Video Station or mobile app (Qfile, Qmusic, Qphoto or Qvideo).
- Note: The Media Streaming add-on app must be installed from the QTS App Center.

## HD (HybridDesk) Station 3.1

- Playback videos, music, photos on TV with Kodi via HDMI
- Watch various online contents
- Web browsers (Chrome, Firefox)
- Supports international keyboards, input and mouse
- Supports QNAP Qremote app and the official Kodi remote app
- Supports user login permissions
- A variety of applications are available including Skype, Plex Home Theater, and more
- Up to 7.1 channel audio passthrough is supported
- Note:
  - The playback and quality of some video files may be affected by the system's CPU and GPU decoding abilities.

## Linux Station

- Use your NAS as a Linux Desktop using the NAS HDMI output
- Supports remote desktop to monitor and access remotely
- An open source software platform for developers

## Virtualization Station

- Supports Virtual Machine (VM) creation to run operating systems such as Windows, Linux, Unix and Android
- Supports VM import and export
- Supports VM cloning & snapshots
- Supports VM backup and restore
- VM console can be displayed via HDMI output - QVM
- HTML5-based shared remote console
- Supports three different networking modes: Isolated, External-only and Bridged

## Container Station

- Supports LXC and Docker
- Download applications from the built-in Docker Hub Registry
- Supports one-click installation, container export/import & console mode
- Supports auto port forwarding
- Supports auto-start containers
- Supports downloading Docker certificates

## Qsirch

- Supports full-text search & near real-time search
- Bar chart to show data distribution
- Supports previews for photos, music, videos, Gmail, PDF, etc
- Show search results using thumbnails or a list
- Supports search Chrome extension

## Storage Plug & Connect

- Creating and mapping shared folders by QNAP

- Windows Qfinder
- Creation of and connection to iSCSI target/LUN

## iSCSI (IP SAN)

- iSCSI target with multi-LUNs per target (Up to 256 targets/LUNs combined)
- Supports LUN mapping & masking
- Online LUN capacity expansion
- Supports MPIO & MC/S
- iSCSI LUN backup, one-time snapshot, and restoration
- iSCSI connection and management by QNAP Windows Qfinder
- Virtual disk drive (via iSCSI initiator)
- Stack chaining master
- Max No. of virtual disk drives: 8

## Surveillance Station

- Supports over 3,000 IP cameras
- Includes 4 free camera licenses, up to 40 camera channels by purchasing additional licenses<sup>3</sup>
- Instant playback to check recent events
- Visual aid by e-map
- Playback and speed control using the shuttle bar
- Video preview on playback timeline
- Intelligent video analytics (IVA) for advanced video searching
- Surveillance client for Mac
- Mobile surveillance app: Vmobile (iOS and Android)
- Mobile recording app: Vcam (iOS and Android)

## VPN Server

- Secure remote access: PPTP, L2TP/IPsec & OpenVPN VPN services
- Max number of clients: 30

## VPN Client

- Supported VPN protocols: PPTP & OpenVPN services
- PPTP Authentication: PAP, CHAP, MS-CHAP, MS-CHAPv2
- PPTP Encryption: None, AES 40/128 bit, AES 256 bit
- OpenVPN Encryption: None, AES 40/128 bit, AES 256 bit
- Transmission package monitor
- OpenVPN port control
- OpenVPN link compression

## DLNA Server

- Supports DLNA/UPnP TVs and players such as PlayStation 4 and Xbox One
- Supported audio formats: AIFF, APE, DSD (DSF, DFF), FLAC, M4A, M4A Apple Lossless (ALAC), MP3, Ogg Vorbis, WAV (PCM, LPCM), WMA, WMA PRO, WMA VBR
- Support CUE indexing file for APE, FLAC audio format.
- Video and Audio On-the-fly Transcoding

## Qcenter (NAS CMS)

- Multiple NAS monitoring
- Utilization history reports
- Unified configuration management
- Visual display reports
- Monitor NAS behind NAT routers with Qcenter Assistant
- Virtual appliances supported by Microsoft Hyper-V and VMware ESXi

## OceanKTV

- Use the NAS as a karaoke machine.
- Display songs by artists, languages, and favorites.
- Enhance the experience with effects such as tuning echo, key, or applause
- Control the playlist with a mobile app.
- Supports keyboard, mouse and remote control (RM-RF001/ RM-IR002).
- Note: Microphone not included.

## iTunes Server

- Audio and video sharing for Windows & Mac iTunes

## App Center

- Over 100 official and community software add-ons such as Photo Station, Music Station, Video Station, Download Station, Notes Station, Signage Station,

<sup>1</sup> Not all IPv6 services are supported.

<sup>2</sup> Data encryption functions may be unavailable in accordance with the legislative restrictions of some countries.

<sup>3</sup> This feature may vary by model.

<sup>4</sup> DRM-protected content is not supported.

Designs and specifications are subject to change without notice.

# Lightweight. Compact. All-flash NAS. Integrated Network Switch

TBS-453A 4-Bay  
M.2 SSD NASbook ▶



Quad-Core  
1.6GHz



## QNAP Systems, Inc.

TEL : +886-2-2641-2000 FAX : +886-2-2641-0555 Email: [qnapsales@qnap.com](mailto:qnapsales@qnap.com)  
Address : 3F, No.22, Zhongxing Rd., Xizhi Dist., New Taipei City, 221, Taiwan

QNAP may make changes to specification and product descriptions at any time, without notice.

Copyright © 2016 QNAP Systems, Inc. All rights reserved.

QNAP® and other names of QNAP Products are proprietary marks or registered trademarks of QNAP Systems, Inc.

Other products and company names mentioned herein are trademarks of their respective holders.



### Netherlands (Warehouse Services)

Email : [nlsales@qnap.com](mailto:nlsales@qnap.com)  
TEL : +31(0)107600830

### Germany

Email : [desales@qnap.com](mailto:desales@qnap.com)  
TEL : +49-89-381562991

### China

Email : [cnsales@qnap.com.cn](mailto:cnsales@qnap.com.cn)  
TEL : +86-400-628-0079

### India

Email : [indiasales@qnap.com](mailto:indiasales@qnap.com)

### US

Email : [usasales@qnap.com](mailto:usasales@qnap.com)  
TEL : +1-909-595-2782

### Thailand

Email : [thsales@qnap.com](mailto:thsales@qnap.com)  
TEL : +66-2-5415988



51000-024062-RS  
201602 (ENG) A